

# TTV 678G / 300T

## RIDE-ON SCRUBBER DRYER

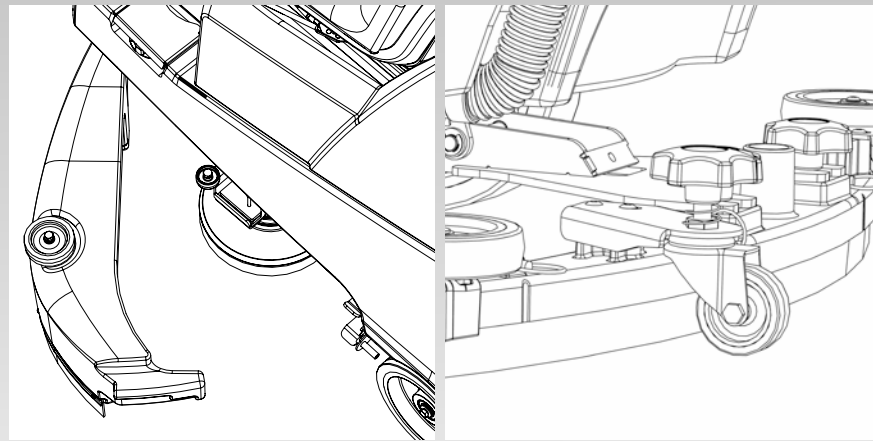

TTV 678G



# Owner Instructions

Warning! Read instructions before using the machine



Before continuing, please refer to Quick Set Up Guide on Page 8



<b>Index</b>	Page 2
<b>Machine Overview</b>	Page 3
<b>Control Panel Overview</b>	Page 4
<b>Rating Label / Personal Protective Equipment / Recycling</b>	Page 5
<b>Safety Precautions</b>	Page 6 / 7

## Quick Set-up Guide

Page 8

### Machine set-up

Fitting the side pod skirts	Page 9
Fitting the floor-tool	Page 9
Fitting the hose Guide / Breakaway floor-tool feature	Page 10
Fitting the brushes	Page 11
Setting the width	Page 12
Filling the clean-water tank	Page 12
Chemical dosing system	Page 13
Pre-cleaning advice	Page 13

### Machine Operation

Lowering the brush-deck	Page 14
Lowering the floor-tool	Page 14
Adjusting the seat	Page 15
Setting the cleaning controls	Page 15
Setting the operator pre-set buttons	Page 16
Waste tank warning light	Page 16
Brush pressure / load adjustment	Page 16
Emergency stop button and horn	Page 17
Machine usage advice	Page 17

### Machine Cleaning

Tanks and Filters	Page 18
Changing the Floor-tool Blades	Page 19

### Machine Charging

<b>Battery care</b>	Page 21
---------------------	---------

Free Wheel Function	Page 22
---------------------	---------

Off-aisle Cleaning Function (optional)	Page 23
--	---------

Trouble Shooting / Specifications	Page 24 - 26
-----------------------------------	--------------

Recommended Spare Parts	Page 27
-------------------------	---------

Schematic Diagrams	Page 28
--------------------	---------

Declaration document	Page 30
----------------------	---------

Warranty	Page 31
----------	---------

Company Address	Page 32
-----------------	---------

# Machine Overview



1	Operator Control Panel (see page 4)	13	Gel batteries
2	Brush load-adjuster knob	14	Chemical dosing tank ( 5 litre )
3	Brush deck release lever	15	Charger
4	Brush deck foot pedal	16	Accelerator pedal
5	Clean-water tank fill point	17	Clean-water Tank Emptying Hose & Fill Level
6	Side Pod (adjustable)	18	Semi parabolic floor-tool
7	Brush deck motors x3	19	Vacuum hose
8	Brush deck cover adjustment / width lever	20	Waste-water emptying hose
9	Floor-tool raise / lower lever	21	Floor-tool vacuum hose
10	Seat adjustment lever	22	Air separator assembly
11	Separator release catches	23	Pedestrian warning light
12	40 Amp battery fuses x3	24	Water and detergent pumps

# Control Panel Overview

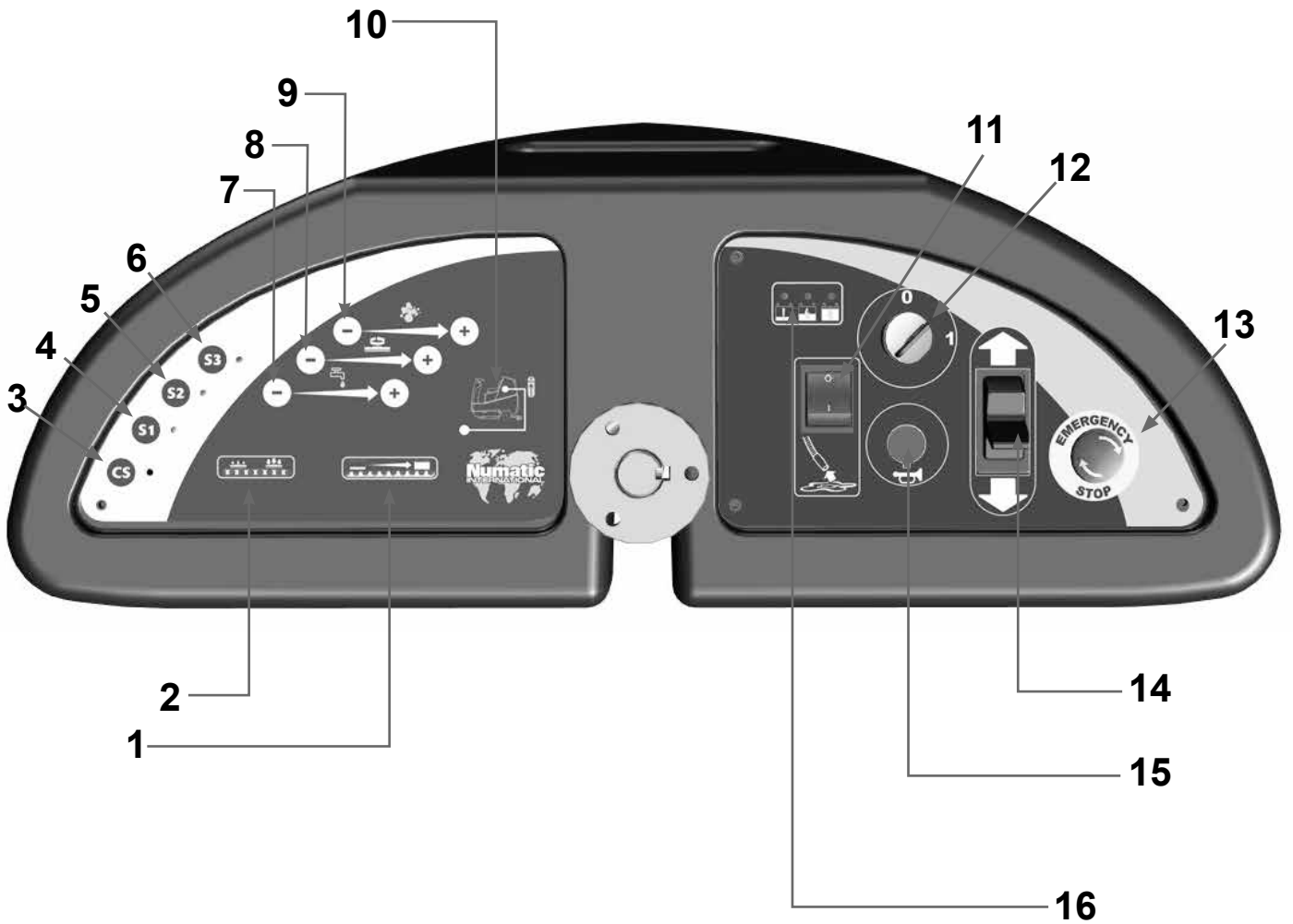

1	Battery Charge Level Meter	10	Waste-water 'Full' Indicator
2	Brush Pressure / Load Indicator	11	Off Aisle Vacuum Button
3	Clean Speed Button	12	Main control On / Off key
4 / 5 / 6	Operator Pre-set Buttons	13	Emergency Stop Button
7	Water Flow Rate Indicator	14	Forward / Reverse Switch
8	Brush Speed Indicator	15	Horn Button
9	Chemical Mix Indicator	16	Charger status light

*For full easy to follow instructions on control panel set up and use, see machine operation page 15-17.*

# About the Machine

## Rating Label

- ① Company Name & Address
- ② Machine Description
- ③ Voltage Frequency
- ④ Power Rating
- ⑤ WEEE Logo
- ⑥ Ingress Protection Rating
- ⑦ Max Gradient
- ⑧ CE Mark
- ⑨ Weight (ready to use)
- ⑩ Machine year/week Serial number

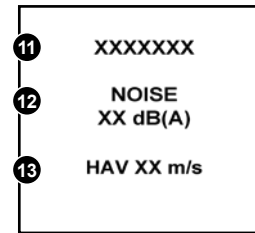
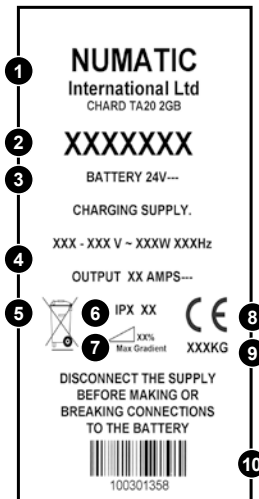

- ⑪ Machine Description
- ⑫ Noise Rating
- ⑬ Hand Arm Vibration

## WEEE (Waste, Electrical and Electronic Equipment)

Scrubber dryer Accessories and packaging should be sorted for environmentally-friendly recycling. **Only for EU countries.**

Do not dispose of scrubber-dryer into household waste.

According to the European Directive 2002/96/EC on waste electrical electronic equipment and its incorporation into national law.

Scrubber-dryers that are no longer suitable for use must be separated, collected and sent for recovery in an environmentally-friendly manner.

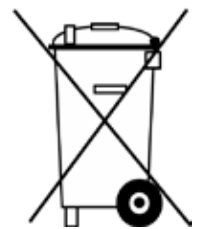

## PPE (Personal protective equipment) that may be required for certain operations.

Ear Protection	Safety Footwear	Head Protection	Safety Gloves	
Dust/Allergens Protection	Eye Protection	Protective Clothing	Hi-Vis Jacket	
				Caution Wet Floor Sign

### Note:

A risk assessment should be conducted to determine which PPE should be worn.

### Safety Critical Component

Charging Lead: H05VV-F x 1.0 mm<sup>2</sup> x 3 core

Battery Charger: 120V (50-60Hz)

DC Output: 24VDC, 20A

Motor Wheel & modified brake lead assembly (904964)

**In the event of a breakdown contact your Numatic dealer or the Numatic Technical help line +44 (0)1460 269268**

# Information for Scrubber Dryer



## ORIGINAL INSTRUCTIONS READ MANUAL BEFORE USE

Component	Interval	Inspect for
Charging Lead	DAILY	Scuffing, cracks, splits, conductors showing
Brushes	DAILY	Bristle damage, wear, drive collar wear
Squeegee Blade	BEFORE EACH USE	Wear, cracks, splits
Filters	BEFORE EACH USE	Clogging and debris retention
Tanks	AFTER EACH USE	Rinse dirty water tank after use



### WARNING

As with all electrical equipment care and attention must be exercised at all times during its use, in addition to ensuring that routine and preventative maintenance is carried out periodically in order to ensure its safe operation.

Failure to carry out maintenance as necessary, including the replacement of parts to the correct standard could render this equipment unsafe and the manufacturer can accept no responsibility or liability in this respect. When ordering spare parts always quote the Model Number / Serial Number specified on the Rating Plate.

This appliance is not intended for use by persons (including children) with reduced physical, sensory or mental capabilities, or lack of experience and knowledge, unless they have been given supervision or instruction concerning use of the appliance by a person responsible for their safety.

Children should be supervised to ensure that they do not play with the appliance.

When detergents or other liquids are used, read the manufacturer's instructions.

This machine is not suitable for picking-up hazardous dust.

Do not use on surfaces having a gradient exceeding that marked on the appliance.

The machine is not to be stored outdoors in wet conditions.

This machine is for indoor use only.

Read the instruction manual before using the appliance.

This product meets the requirements of IEC 60335-2-72, Sub Clause 20.1.



### CAUTION

#### NOTES

This machine is also suitable for commercial use, for example in hotels, schools, hospitals, factories, shops and offices for other than normal housekeeping purposes.



### DO

- Ensure only competent persons unpack/assemble the machine.
- Keep your machine clean.
- Keep your brushes in good condition.
- Replace any worn or damaged parts immediately.
- Regularly examine the charger lead for damage, such as cracking or ageing.  
If damage is found, replace the lead before further use.
- Only replace the charger lead with the correct Numatic approved replacement parts.
- Ensure that the work area is clear of obstructions and / or people.
- Ensure that the working area is well illuminated.
- Pre-sweep the area to be cleaned.



### DON'T

- Use steam cleaners or pressure washers to clean the machine or use in the rain.
- Attempt machine maintenance or cleaning unless the power plug has been removed from the supply outlet, if the machine is in charge mode or remove the key if in normal use.
- Allow any inexperienced repairs. Call the experts.
- Strain charger lead or try to unplug by pulling on charger lead.
- Leave the brush pad on the machine when not in use.
- Allow the machine to be used by inexperienced or unauthorised operators or without appropriate training.
- Expect the machine to provide trouble-free, reliable operation unless maintained correctly.
- Run the machine over power cable during operation.



### WARNING

Only use brushes provided with the appliance or those specified in the instruction manual.

The use of other brushes may impair safety.

A full range of brushes and accessories are available for this product.

Only use brushes or pads which are suitable for the correct operation of the machine for the specific task being performed.

It is essential that this equipment is correctly assembled and operated in accordance with current safety regulations.

When using the equipment always ensure that all necessary precautions are taken to guarantee the safety of the operator and any other persons who may be affected. Wear non-slip footwear when Scrubbing. Use a respiratory mask in dusty environments.

The machine, while charging, must be positioned so that the mains plug is easily accessible.

Remove the key from the ignition when cleaning and carrying out routine maintenance.

When replacing major components the ignition key and battery fuses MUST be removed.

In order to prevent unauthorized use of the machine, the power source shall be switched off or locked, for example by removing the ignition key.

When detergents or other liquids are used, read the manufacturer's instructions.

Operators shall be adequately instructed as to the correct use of the machine.

If this product does not have a factory installed Numatic battery charger, then it is the responsibility of the owner and user of the product to ensure that the charging system and battery combination are compatible, fit for purpose and safe to use.

## Precautions when working with batteries

1. Always wear protective clothing e.g. face visor, gloves and overalls when working with batteries.
2. Whenever possible always use a properly designated and well-ventilated area for charging.  
Do not smoke or bring naked flames into the charging area.
3. Remove any metallic items from hands, wrists and neck i.e. rings, chains etc. before working on a battery.
4. Never rest tools or metallic objects on top of the battery.
5. When charging is complete disconnect from the mains supply.
6. The machine must be disconnected from the supply when removing the battery.
7. To remove the batteries:- Disconnect machine from the mains supply (if charging), raise waste water tank and ensure batteries are isolated by removing fuses. Disconnect hoses from separator and tanks, undo battery terminals and remove batteries.
8. Only use genuine Numatic replacement batteries.
9. Do not allow the batteries to become fully discharged, it may not be possible to recharge them.
10. Do not allow one battery to be discharged separately to the other.
11. Do not mix batteries from different machines.
12. The batteries fitted to this product are Valve Regulated Lead Acid (VRLA) gel electrolyte type.  
The fitting of any other type of battery may cause a safety hazard.
13. The batteries must be removed from the machine before it is scrapped.
14. Dispose of the batteries safely in accordance with local government regulations.

## Battery care

### 1. Battery Storage:

- a. Batteries must be stored in a dry, level and clean location not exceeding a temperature range of 5°C to 25°C.
- b. Batteries must be fully charged after 6 months when on-the-shelf and as a minimum every 3 months thereafter or if the battery voltage reduces to 12.6V.
- c. Batteries must be put into use within 12 months of the date of manufacture, failure to do so will lead to reduced capacity in the field. (battery date code) - silver label on the battery - (e.g. 1649) = Year - 2016 / Week - 49.
- d. If a battery reaches 10.5V, irreversible damage has occurred. Under this condition, a battery should not enter into service and should be disposed of according to local authority guidelines.

### 2. During Use:

- a. Batteries must be recharged after every use regardless of machine run time
- b. If the machine is to be left dormant for any length of time complete the following:
  - i. Fully charge the batteries and remove the battery fuses
  - ii. Every 3 months insert the fuses and recharge
  - iii. Do not leave batteries dormant for more than 6 months

### 3. Warranty:

- a. Batteries are warranted for 600 cycles (2 Years) providing all battery care rules are followed
- b. To claim warranty the following details must be supplied
  - i. Serial number of the machine
  - ii. Battery date code (Show picture of battery date code)
  - iii. Date purchased
  - iv. Proof of Purchase
  - v. Maintenance history and charging regime

### Daily

Keep the machine clean.  
Ensure brushes/ pads/ squeegee/ filters are in good condition.  
Check for any worn or damaged parts and replace immediately.  
Drain and rinse dirty water tank after every use.  
Store machine with brush deck secured in tilted position.

### Weekly – as daily and –

Check brush or pad and skirt and rinse.  
Check floor tool blades for wear and wipe clean.  
Clean separator assembly including filter and check condition of seal.  
Flush out system with clean water and clean filters.  
Do not steam clean or pressure wash.

### Batteries

Always recharge the batteries after use.  
Charge for a minimum of 4 hours after the green light has come on, this will prolong battery life.

TwinTec  
Maintenance

# Quick Set-Up Guide



**PLEASE READ BEFORE COMMENCING ANY OPERATION.  
AFTER THE REMOVAL OF ALL THE PACKAGING,  
CAREFULLY OPEN AND CHECK THE CONTENTS OF THE START UP PACK FIG.1.**



## Contents:

- 1 x Operator Manual
- 2 x Battery charging lead
- 2 x Keys
- 4 x 40 amp fuses (1 x spare)
- 2 x Side pod skirts
- 1 x Brake disengage key
- 1 x Maxi fuse-puller

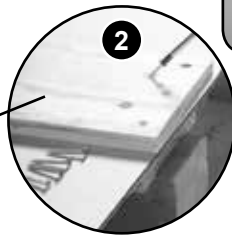
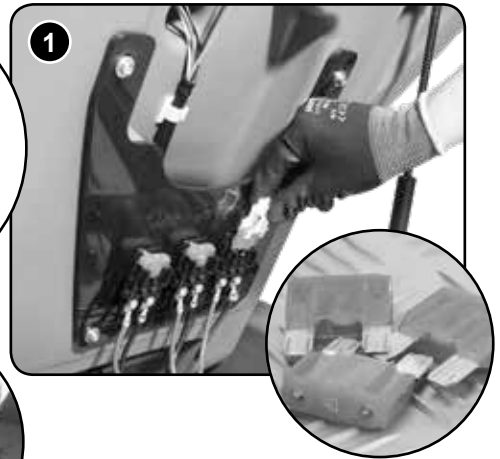
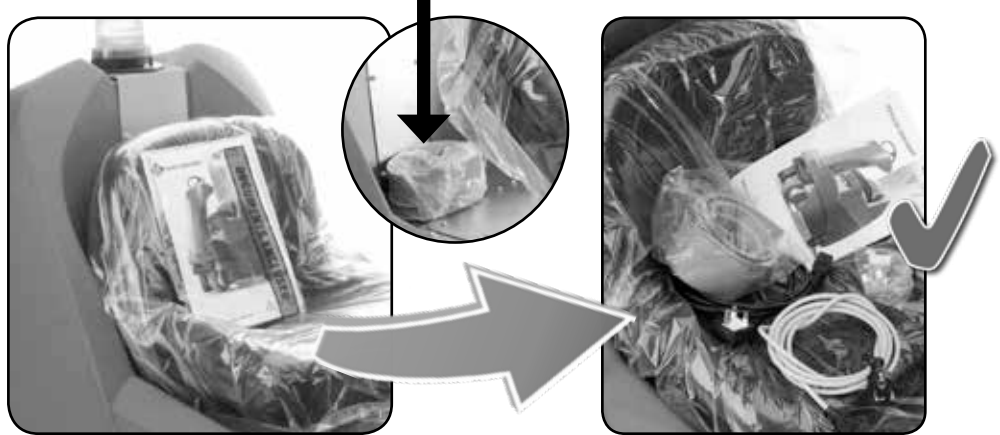

Lift top tank assembly to reveal battery compartment.  
Always lift between points as illustrated to ensure personal safety.  
Fit battery fuses (contained in start-up pack) into the battery fuse holders as illustrated (Fig.1).  
Remove transit block from pallet (Fig.2).

**Note:** Ensure that no metal objects come into contact with battery terminals while the batteries are exposed.  
When inserting the first fuse you may notice a spark, this is normal.



Insert key into main control (on / off) and turn quarter-turn clockwise to position (1) 'On' (Fig.3).  
Ensure that the forward / reverse switch is set to forward (Fig.4).  
Depress accelerator pedal with right foot and slowly drive machine off of the pallet using the ramp provided (Fig.5).

**Note:** The seat is fitted with a pressure sensor that disables the machine until an operator is seated.

When the machine is removed and in a safe position, turn key back to the position (0) 'OFF' (Fig.6).





## Machine Set-up



**ALWAYS ENSURE THAT THE MACHINE IS SWITCHED OFF  
BEFORE MAKING ANY ADJUSTMENTS**

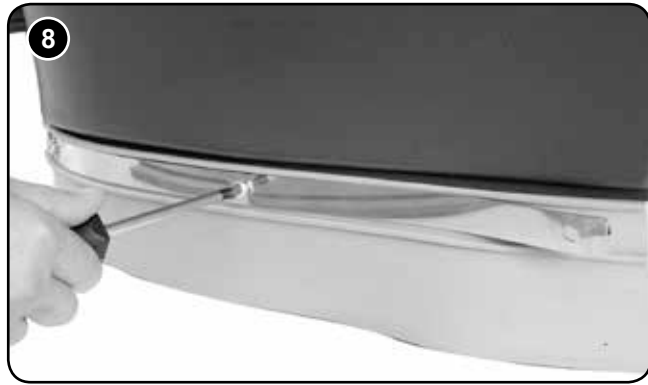

To fit the side pod skirts, first remove the steel retaining strip already fitted to the pod (Fig.7). Align the steel retaining strip within the locating grooves of the rubber skirt and refit using existing screws (Fig.8) Periodically the side skirts should be examined and checked for wear and damage. Replace as shown above.

### Fitting the Floor-tool

Lower the floor-tool arm by moving the release lever to the upper position (Fig.9). Push floor-tool onto the holder and secure with the easy-fit securing pin (Fig.10). Push waste collection pipe onto the floor-tool; ensure a tight fit (Fig.11).

**Note: Raise floor-tool again before driving to the cleaning area (Fig.12).**

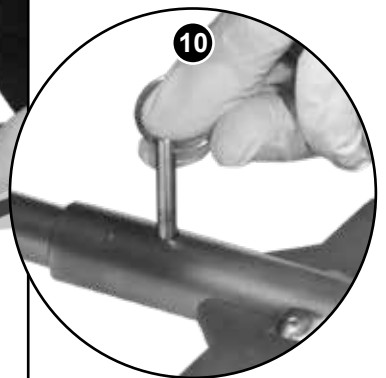

## Machine Set-up

### Fitting the Hose Guide

The vacuum hose has a U-bend clip which creates a U-bend in the hose preventing water spillage when the vacuum is switched off. If you need to remove the U-bend clip for any reason always ensure it is refitted correctly before you resume operation.

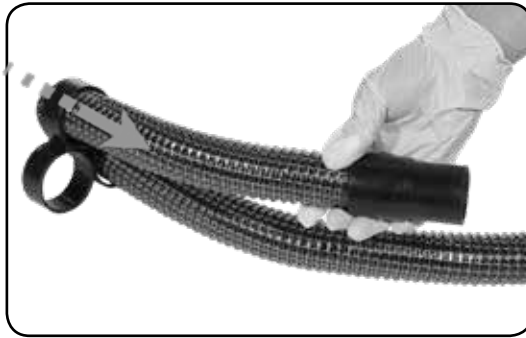

Refit vacuum hose to the Floor-tool when finished.

#### **Note:**

*DO NOT push the vacuum hose onto the Floor-tool with the Floor-tool in the raised position.*

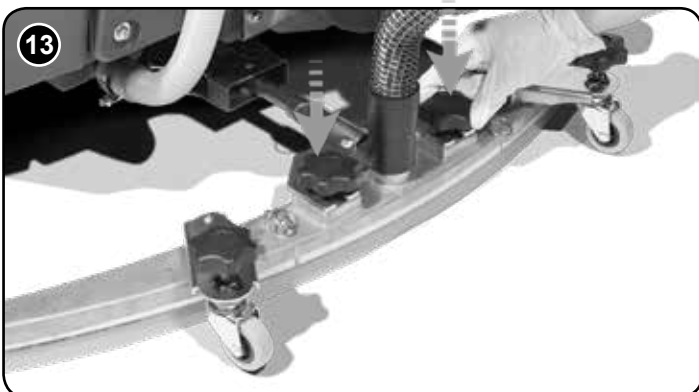

### Breakaway Floor-tool

The floor-tool design incorporates a safety knock-off feature.

Allowing it to safely disengage from its mounting should it become caught on an obstruction, during forward machine movement.

To re-attach the floor-tool blade to its holder. First loosen the retaining knobs on the floor-tool body and slide onto the holding bracket.

Tighten retaining knobs to finger tight. (See Fig.13).

# Machine Set-up

## Fitting the Brushes

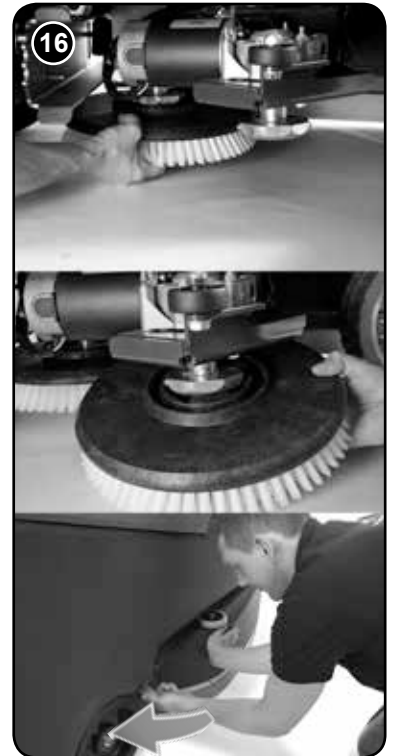
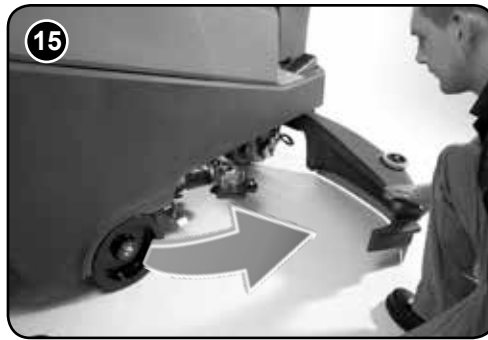

**Featuring the OBS (Octagonal Brush System); the brushes simply push-fit up onto the chucks making fitting and removal a simple process.**

Pull the side pod adjustment lever and set to the top position (Fig.14).

The side pod will now pull open (Fig.15).

Fit middle brush first (brushes will click-fit onto the OBS drive chuck).

Fit outer brush next on both sides.

Close side pod and while keeping the side pod pushed in,

set to appropriate width (see setting the width) (Fig.16).

**Safety gloves are recommended for the changing of used brushes.**

Owning the TTV 678G / 300T ride-on scrubber dryer is like having 3 machines in one. With three width-settings the operator can quickly adapt the machine to any cleaning situation; without the need for any tools. The machine can be set to clean anything from a narrow corridor to a large warehouse. The TTV 678G / 300T is a totally versatile machine.

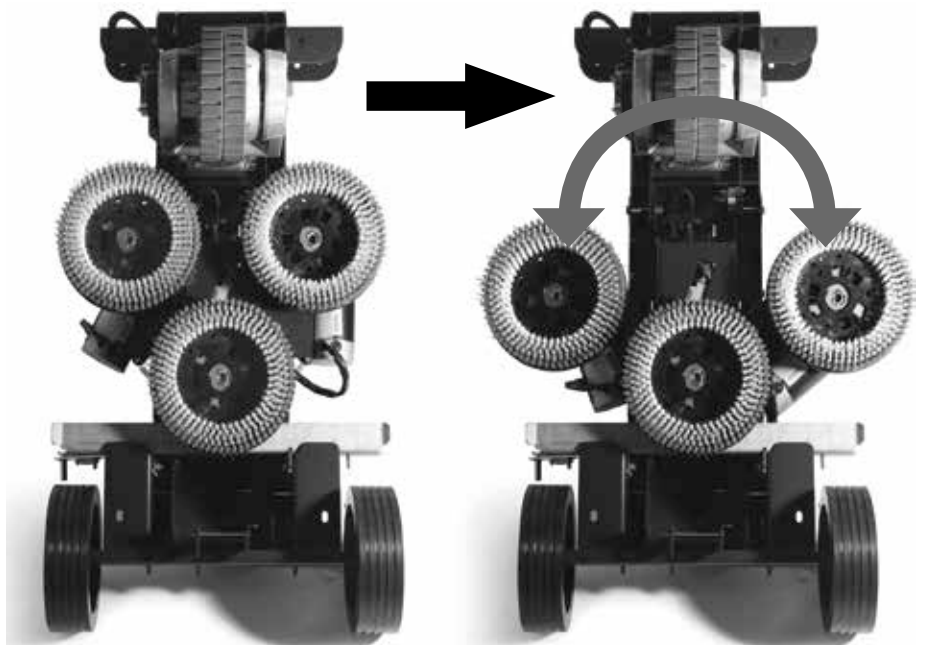

# Machine Set-up

## Setting the Width Adjustment

First push the side pod in (see Fig.17), then pull the side pod adjustment lever and set it to one of the three width-settings (see Fig.18) Repeat the operation on both sides.

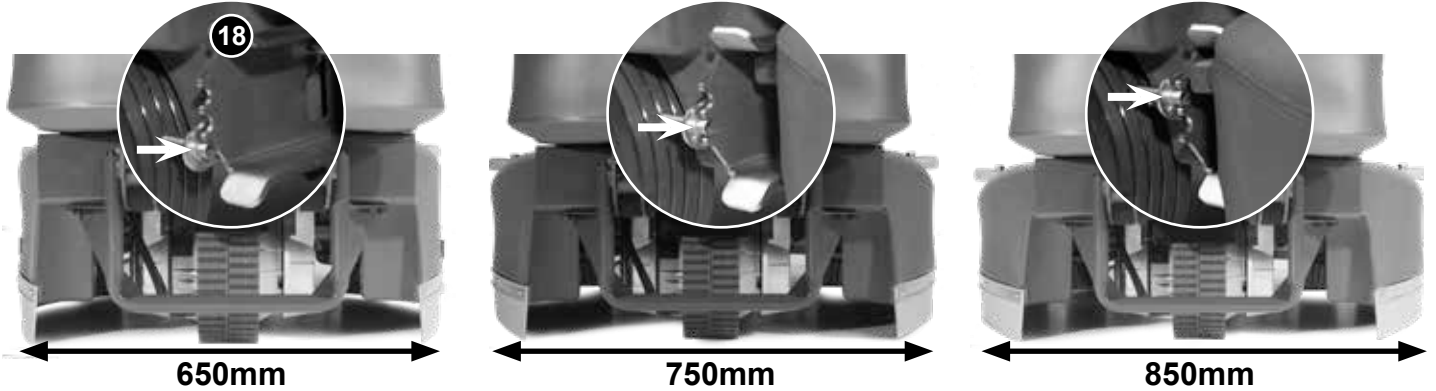

## Filling the Clean-water Tank

The TTV 678G / 300T is equipped with a large capacity 120 litre clean-water tank allowing, for large areas to be covered in a single fill.



To fill the clean-water tank, lift the cover flap (Fig.19) to expose the filler cap. Unscrew the filler cap (Fig.20) and fill the tank using a hose (Fig.21) or preferred method.

**Note:** Great care must be taken to ensure that contaminants (leaves, hair, dirt, etc.) are not allowed to enter the clean-water tank during the filling process. If using a bucket or similar, ensure it is always clean and free from debris.



### Fill-level indicator

The water level in the clean-water tank can be measured using the scale on the rear of the machine (Fig.22).



## Chemical dosing system



**WHEN HANDLING AND MIXING CHEMICALS**  
Always ensure that chemical manufacturer's safety guidelines are followed.  
Only use chemicals recommended for use in auto scrubber-dryers.



**IMPORTANT**  
Do not operate machine unless the Operator Manual has been read and fully understood.



The TTV 678G / 300T ride-on scrubber dryer has an optional automatic chemical-dosing system. Simply fill the 5 litre chemical dosing bottle and the machine will deliver the correct mix ratio as set by the operator, depending on the floor and cleaning conditions. (See page 15)

23



24



25



To fill the chemical dosing bottle, first lift up the waste-water tank (Fig.23), remove the dosing bottle, unscrew the bottle cap (Fig.24) and fill with appropriate cleaning chemical. Replace bottle cap, refit dosing bottle (Fig.25) and carefully lower waste-water tank.

*After use, ensure the chemical dosing tank is emptied, cleaned and refilled with clean water. The dosing pipes also need to be cleaned and flushed through with clean-water for at least 60 seconds.*

**Note:** always ensure that the waste-water tank is empty before lifting.

The machine is now ready to be driven to the cleaning site.



Before performing the cleaning operation, place out appropriate warning signs and sweep or dust-mop the floor.

## Machine Set-Up

### Lowering the Brush Deck



After preparing the floor (see previous section), we are now ready to set the controls to suit the cleaning conditions. Before any settings can be applied, ensure the brush deck is lowered. While depressing left-hand foot pedal (see Fig.26), press down the release lever (see Fig.27) and gently release the foot pedal to lower the brush deck (see Fig.28).

**Note:** If the brush width has not been set, see 'Setting the width adjustment' on page 12 before proceeding.

### Lowering the Floor-tool

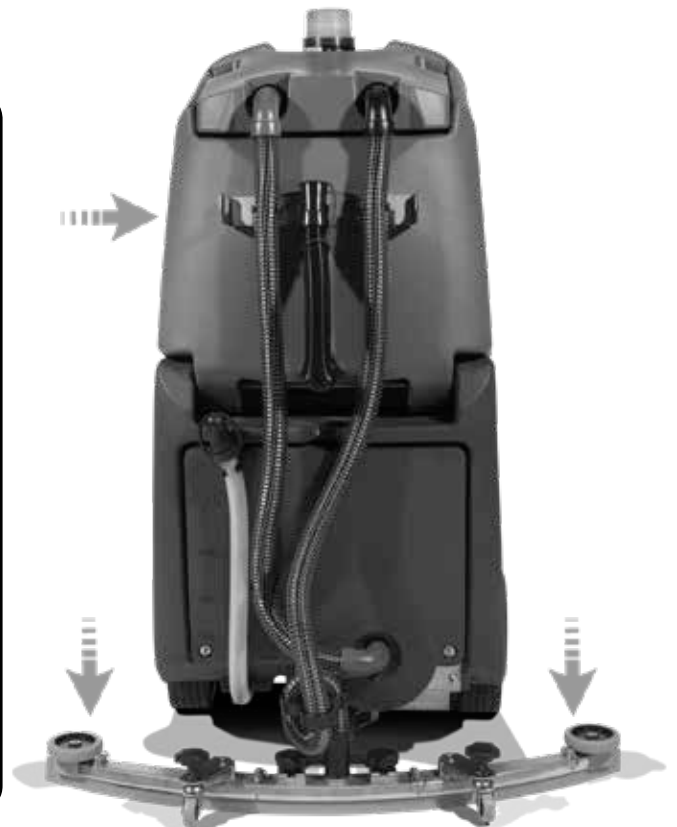

Lower the floor-tool by moving the release lever to the upper position (Fig.29).

**Note:** The machine will not reverse while the floor-tool is in the lowered position - 'Causes the battery indicator to flash'.

# Machine Operation

## Adjusting the Seat



Sitting in the driving position, adjust the seat forwards or backwards as necessary by using the lever found on the left-hand side (see Fig.30).

**Note: The seat is fitted with a pressure sensor that disables the machine until an operator is seated.**

## Setting the Cleaning Controls

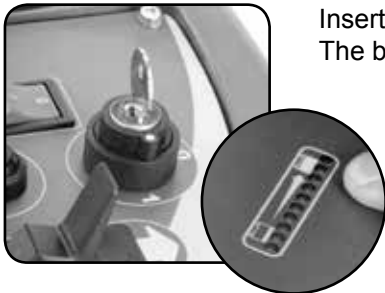

Insert key into main control (on / off) and turn quarter-turn clockwise to position (1) 'ON'. The battery charge level meter will illuminate.

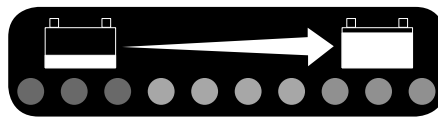

Set automatic Chemical Dosing Mix as required, depending on floor type and level of soiling.

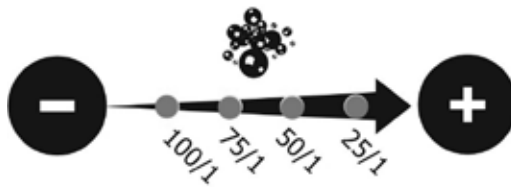

Set desired Brush Speed as required, depending on floor type and level of soiling.

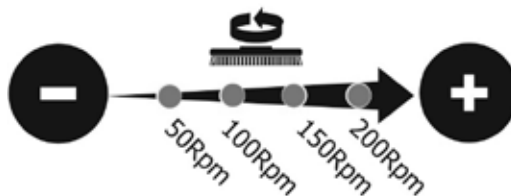

Set Water Flow Rate as required, depending on floor type and level of soiling.

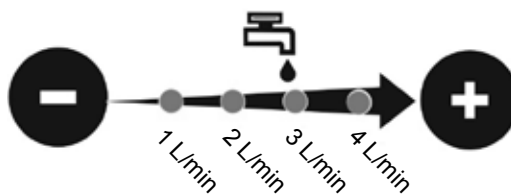

# Machine Operation

## Setting the Operator Pre-set Buttons



Settings can be stored using one of the three pre-set store buttons (S1 / S2 / S3). Once settings are entered (chemical dose, brush speed and water-flow), press and hold one of the three pre-set store buttons, a light will flash then remain constant; your settings are now saved. This facility can be re-set as often as you wish by simply following the steps above.



Cleaning Speed setting (CS). When this button is activated the speed is restricted to 3.5 km/h maximum even with the accelerator pedal fully depressed. This is ideal for long cleaning periods. Once this pre-set button is switched-off, the machine will operate at up to a maximum speed of 7.0km/hr.



## Waste-water Tank Fill Level Warning Light



When the waste water-tank becomes full, a red warning light will illuminate on the operator control panel (as illustrated) and the vacuum motor will stop automatically after 5 seconds. The waste-water tank requires emptying (see page 18).



## Brush Pressure / Load Adjustment



The machine is equipped with a brush-pressure load-warning system. If the brush load increases due to changing floor types, the pressure can be adjusted manually by the operator using the adjuster knob found on the left hand side of the control column.



Turn it anti-clockwise to decrease load on the brushes and clockwise to increase load / pressure on the brushes (see Fig.31).

**Note:** The run-time of the machine may decrease if the load on the brushes is increased.



# Machine Operation

## Emergency Stop Button and Horn



The TTV 678G / 300T is equipped with an **electronic braking system**.  
Simply lift your foot from the accelerator and the machine will stop.  
In an emergency, strike the emergency-stop isolator button  
The machine will be disabled.  
To reset, turn the isolator button clockwise (see Fig.32).  
After resetting the emergency stop button, to restart the machine, turn the ignition key to the off then the on position again.  
The **horn** is located on the right-hand side of the operator control panel (see Fig.33).



**ALWAYS ENSURE THAT THE FLOOR IS PRE-SWEPT AND RELEVANT SAFETY SIGNS ARE DISPLAYED**



## Machine In Use



To operate, select forward or reverse, press the accelerator pedal. Vacuum pick-up, water-flow and chemical-dose will turn on automatically and the machine will move forward.

The clean-water / chemical mix is dispersed evenly via 'THRU- FEED' scrubbing brushes.

The waste-water is then retrieved by the suction floor-tool (see Fig.34). Overlap each scrubbing path by 10cm to ensure an even clean. Do not operate the machine on inclines that exceed 11%.

**Note:** Care must be taken to reduce speed when cornering or when manoeuvring around obstacles..



On heavily soiled floors use a 'double scrub' technique. First pre-scrub the floor with the floor-tool in the raised position, allow the chemical time to work then scrub the area a second time with the floor-tool lowered.

If streaking occurs wipe floor-tool blades clean.

# Machine Cleaning



**ALWAYS ENSURE THAT THE MACHINE IS SWITCHED OFF PRIOR TO ANY MAINTENANCE.**

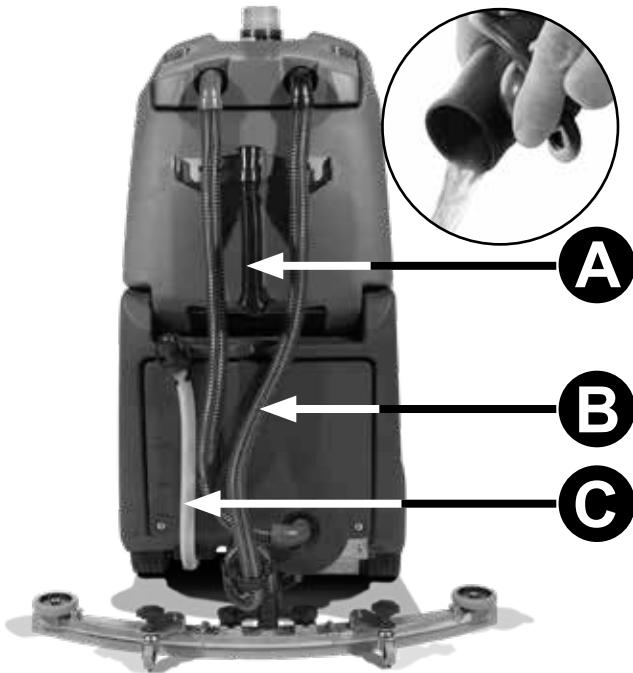

After use, empty waste-water tank using emptying hose **A** and flush-out with clean-water.  
Next remove floor-tool vacuum hose and flush out with clean-water. **B**  
Next empty clean-water tank, using emptying hose **C** and again flush out with clean-water.



Before removing separator, first pull-off connected hoses. Whilst pressing in the separator toggles, remove hood and rinse using clean-water. The hood also has a sealing-rubber which should be examined at every clean-down.

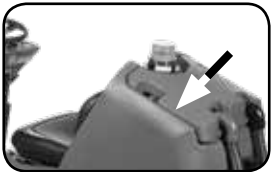

Located in your waste-water (top) tank is a full tank switch, this stops your machine from working once the waste-water reaches its maximum limit. Sometimes the switch gets clogged and blocked, clean to ensure correct operation.



Remove white filter and rinse using clean-water, and refit.

**IMPORTANT:**

Never use the machine without the recommended filter as it may cause damage to the machine.



Remove debris basket filter and rinse using clean-water, and refit.

**IMPORTANT:**

If the debris basket is allowed to become clogged, vacuum performance can deteriorate.



The clean debris basket filter is located under the filler cap. Remove debris basket filter and rinse using clean-water, and refit.



The secondary clean-water tank filter is located to the rear of the battery compartment, and should be checked at regular intervals. Lift white plug and remove the filter, rinse and refit. Ensure tank has been emptied and care is taken when working in the vicinity of batteries.

**NOTE: ANY SPILLS SHOULD BE WIPED-UP BEFORE TANK IS LOWERED.**

# Changing the Floor Tool Blades



**ALWAYS ENSURE THAT THE BATTERY IS DISCONNECTED  
PRIOR TO ANY MAINTENANCE**



## The Floor Tool

The TTV 678G / 300T is provided with the aluminium floor-tool shown.

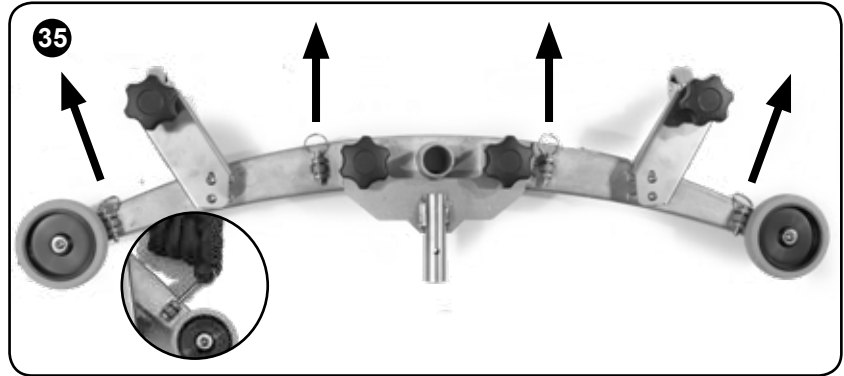

To clean the floor-tool, remove securing-pin and disconnect the lifting strap and remove the floor-tool securing pin pull-free the floor-tool from the rear of the machine.

Rinse the floor-tool assembly with clean-water and refit.

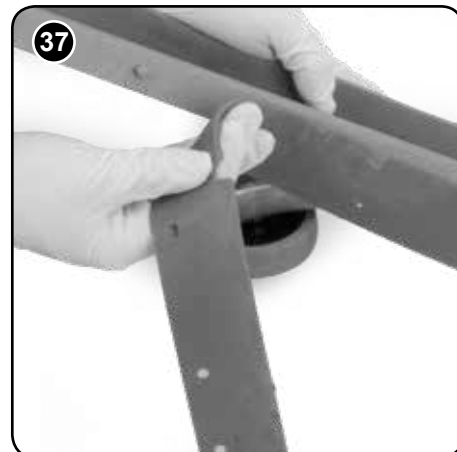
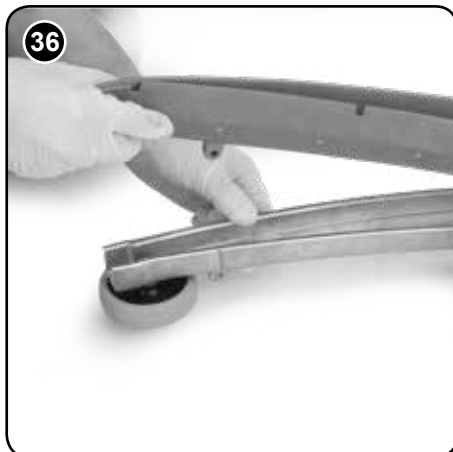

Periodically the floor-tool blades should be examined and checked for wear and damage.

The blade removal is easy. Simply start by removing the four retaining pins (see Fig.35), turn the floor-tool over and separate the blade carrier from the body (see Fig.36). Peel away the blades from their locating lugs (see Fig.37) and examine or renew as required. Replacement is a reversal of the removal process.

### Floor-tool overview

1. Floor-tool main body
2. Rear blade
3. Blade carrier
4. Front blade (slotted)
5. Retaining pins x 4

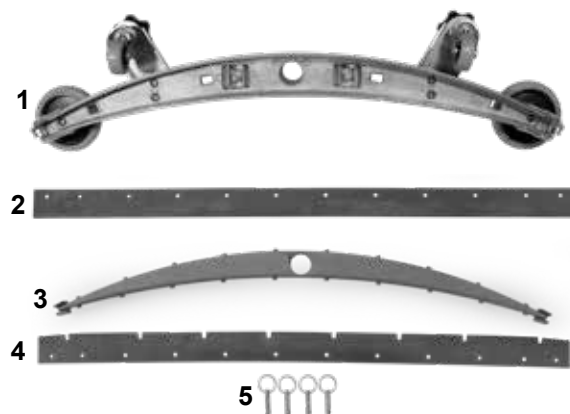

#### Note:

*Floor-tool adjusters are factory set for optimal performance.  
The blades are designed to be reversible, thus extending their useful working life.*

# Machine Charging



**ALWAYS ENSURE THAT THE MACHINE IS SWITCHED OFF PRIOR TO CHARGING.**

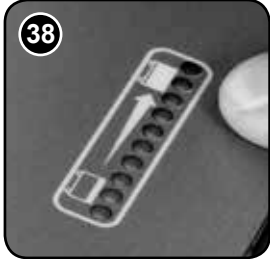

The battery meter displays the charge level of the batteries; when fully charged, all meter lights are illuminated (see Fig.38).



As the machine is used and the batteries are discharged, the meter lights will go out from right to left.



If the battery-charge level is allowed to discharge to the point that only the red light remains illuminated, the operator must consider charging the machine.



If the battery-charge level is allowed to discharge to the point that only one red light remains illuminated (and begins to flash), all cleaning functions will automatically be disabled and the operator should drive the machine straight to a suitable charge point.



The large capacity gel batteries are sealed for life and are totally maintenance free. The on-board charger automatically monitors the charging process and will switch off when the batteries are fully charged. The machine charging point is located under the top tank. (see Fig.39).



Insert the charging lead required for your country (see start up pack) into the charging point and connect to a suitable power supply (see Fig.40).



Once mains power is connected the red charging indicator will illuminate. To ensure a full charge, the machine should be left for a period of 12-14hrs. Once fully charged, disconnect the charging lead from both the power supply and the machine.

## Battery Care



To ensure your machine remains at its maximum efficiency and prolong your battery life, please follow the simple steps below:

### Under normal daily usage:

Recharge batteries after each use regardless of machine operation time (see page 20).

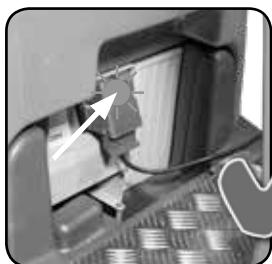

Recharge the machine fully after its last use. Do not leave the machine in a discharged state.



Showing location of Viewing panel for charging-light sequence.

Signal (LED)	Meaning
Red LED on	First Phase (constant current Mode)
Orange LED on	Second Phase (Constant Voltage Mode)
Green LED on	Third Phase (Constant Voltage Mode) Charge Complete
Red LED flashing followed by Pause	Cooling Fan Locked > <b>1 flash between pause</b> Over Voltage Protection / Output Short Circuit / Battery Reverse Polarity > <b>2 flashes between pause</b> Over Temperature Protection > <b>3 flashes between pause</b> Charge Time has exceeded 16 hrs during phase 1 or 2 > <b>4 flashes between pause</b>



**Under abnormal use; i.e. leaving the machine without charging for a period of time, we advise that you follow these steps:**

If the machine will be standing unused for a period of 30 days or more, then batteries must be fully charged and battery fuses removed using the Maxi fuse-puller provided, prior to this period.

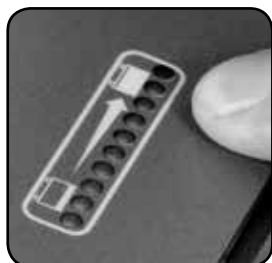

Batteries should be recharged every three months. Charge fully the day before you start using the machine again.



## Free-wheel Function & Towing



**ALWAYS ENSURE THAT THE MACHINE IS ON LEVEL GROUND BEFORE DISENGAGING BRAKE ARM. NEVER DISENGAGE THE BRAKE WHEN THE MACHINE IS ON A SLOPE / GRADIENT. NEVER TOW THE MACHINE WITH THE BRAKE ENGAGED AND POWER PLUG CONNECTED! REMOVE BATTERY FUSES**



The TTV 678G / 300T is equipped with a free-wheel function that will enable the operator to move / tow the machine. The motor brake is disengaged by opening the brake arm on the side of the drive wheel (see Fig.41).



Your start-up kit includes a brake drive disengage key (329945, see Fig.42) which can be inserted between the brake arm and drive housing (see Fig.43).



Once the key has been inserted (see Fig.43) the motor brake will be fully disengaged.  
**The machine will now be in full free-wheel mode.**

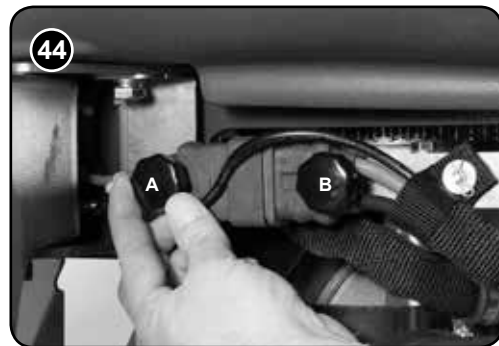

Undo and remove the two retaining knobs (fig.A&B).



Pull the power connector block apart and refit the two retaining knobs.  
When destination place reached, remove brake disengage key, connect power plug, fit fuses

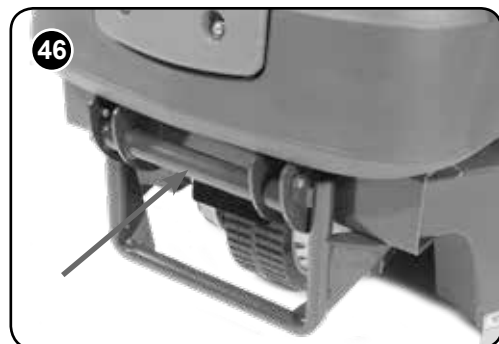

When towing the machine ensure that a suitable tow bar is used.  
Care must be taken when towing; **WHEN TOWING DO NOT EXCEED AVERAGE SPEED OF 3 KPH.**  
The machine can be towed from the front bar as indicated (see Fig.46).



**WARNING!**  
**WHEN THE BRAKE IS DISENGAGED AND POWER PLUG IS DISCONNECTED THE MACHINE IS IN FREE-WHEEL MODE AND HAS NO BRAKE FACILITY, WHEN TOWING THE MACHINE ENSURE THAT A SUITABLE TOW BAR IS USED.**

Remember to remove the brake disengage key when you reach your final destination / before using the machine.  
**NOT FOLLOWING DESCRIBED METHOD COULD DAMAGE MAIN CONTROL UNIT AND VOID THE WARRANTY**



## Off-Aisle Cleaning Kit (Optional Extra Accessory)



The optional off-aisle cleaning kit gives added flexibility to the operator. The kit can be used to clean hard to reach / inaccessible areas. Press the blue auxiliary switch on the dashboard (see Fig.45); ensure the floor-tool is in the **lowered position** (see Fig.46) so only the vacuum will operate and all other functions on the machine will become disabled. If floor-tool is in the **raised position** the vacuum will not operate and the control panel lights will flash. The machine will need to be reset by simply turning the ignition key off and on again.

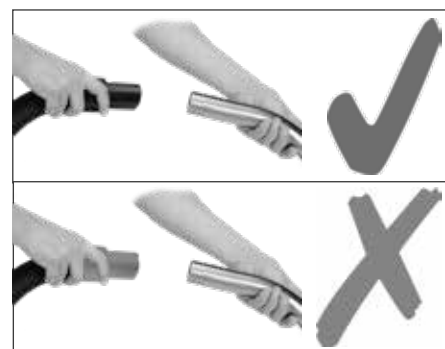

*In the event of a breakdown contact your Numatic dealer or the  
Numatic Technical helpline +44 (0)1460 269268  
(See back page for company addresses or dealers stamp)*

# Trouble Shooting



**Sleeping / rest mode: Battery indicator flashes every 5 seconds indicates machine has been idle for more than 20 minutes. Vario functions disabled cycle key switch!**

Number of bars flashing on display	Fault	Possible Cause	Effect on Product	Investigate the Following	Action Required	If Fault Persists.
<p>* 1 Bar flashes continuously</p> 	<p>* Batteries voltage low.</p>	<p>* Batteries not been charged.                      * Possible bad connection between batteries, controller, charger or fuses caused by loose connections ,                      damaged wiring , water ingress.                      * Not accepting charge due to faulty battery/cell.                      * Charger not functioning.</p>	<p>* Operating time severely reduced or machine will not operate.</p>	<p>* Check when machine last charged.                      * Switch OFF the machine.                      * Remove Fuses.                      * Check connections to batteries, charger and fuses for loose wires or screws.                      * Check each battery Voltage individually to detect defect unit 10.5V min.                      * Check battery voltage and charge current.                      * ensuring charger red fault light is extinguished.</p>	<p>* Charge batteries immediately.                      * Tighten loose connections and replace damaged components.                      * Replace batteries as required.                      * Replace charger.</p>	
<p>* 2 Bars Flash continuously.</p> 	<p>* Traction drive overload.</p>	<p>* Traction drive over current trip due to too high a load.                      * Traction drive is disconnected or has bad connection due to wiring or connectors becoming damaged, loose or corroded due to water ingress.</p>	<p>* Brake engaged no movement.</p>	<p>* Did machine fall on incline. Check traction wheel free from debris.                      * Cycle Key switch to resume normal operation.                      If the above fails then: Switch machine off.                      Check connections and harness between drive motor and controller.</p>	<p>* Cycle key switch to resume normal operation.                      * Tighten loose connections and replace damaged components.</p>	
<p>3 Bars Flash continuously.</p> 	<p>Brush motor over current trip has occurred.</p>	<p>Rough floor surface.                      Brush motor has failed or is damaged..                      Brush motor bad connection.</p>	<p>* Intermittent brush trip.                      * Brush Motor doesn't run or runs intermittently.</p>	<p>* Brush type suitable for floor surface.                      * Cycle Key switch to resume normal operation.                      * If the above fails then: Switch off machine.                      * Check brush motor for damage.                      * Check brush motors turn freely.                      * Cycle key switch to resume normal operation.                      * If the above fails then:                      * Switch machine off.                      * Check connections and harness between Brush Motor and controller.                      * Check BRUSH Motor connections block underneath chassis , behind mud guard for loose wires and loose screws.                      * Cycle key switch to resume normal operation.</p>	<p>* Change brush , adjust brush speed and reduce pressure by turning adjustment knob anticlockwise.                      * Replace effected motor or wiring.</p>	
<p>* 4 Bars Flash once with pause.</p> <p>* 4 Bars Flash twice with pause.</p> 	<p>* System trip.                      * Spare Solenoid connection trip.</p>	<p>* System failure.                      * System has been incorrectly rewired.</p>	<p>* Machine will not operate.                      * Machine will not operate.</p>	<p>* Replace controller.                      * Refer to wiring diagram and check the solenoid/water/detergent pump wiring configuration.</p>	<p>* Rectify wiring fault found.</p>	
<p>* 5 Bars flash continuously.</p> 	<p>* Vac Motor is disconnected, has failed open circuit, has a bad connection or water ingress - temperature trip activated.</p>	<p>* Wiring between Vac motor and Controller is damaged, wiring is loose or wiring connections are loose, possibly wire has come out of a connection block - blocked exhaust</p>	<p>* Vac motor will not operate.</p>	<p>" Cycle Key switch to resume normal operation.                      * If the above fails then:                      * Switch off machine.                      * Check for loose or damaged wiring and connections between Vac motor and controller.                      * Cycle key switch to resume normal operation.</p>	<p>* Tighten loose connections and replace damaged components - check exhaust clean if necessary.</p>	

Contact Service Agent.



Contact Service Agent.

Number of bars flashing on display	Fault	Possible Cause	Effect on Product	Investigate the Following	Action Required	If Fault Persists.
* 6 Bars flash continuously. 	* Control system is inhibiting drive.	* Faulty controller.	* Machine will not operate.	* Check controller for water damage.	* Replace controller.	
* 7 Bars flash once with pause 	* Accelerator pedal trip.	* Accelerator pedal being activated without seat switch being activated (nobody on seat) Or seat switch momentarily deactivated while accelerator pedal being activated during forward / reverse operation.	* Machine will not drive.	* Ensure accelerator pedal is not activated without seat switch being activated. Ensure firm contact with seat by operator at all times while accelerator is pressed.	* Operator to be trained.	
* 7 Bars flash twice with pause.	* Emergency stop has been activated. * Off aisle cleaning activated with floor tool raised.	* Inadvertent pressing of emergency stop or activation of off-aisle cleaning mode.	* Machine will not drive.	* Ensure emergency Stop button has not been activated and off aisle vac switch is in off position with floor tool raised.	* Reset emergency stop button. Switch off aisle vac and raise floor tool. * Cycle key switch to resume normal operation.	
* 7 Bars flash 3 times with pause.	* Vac Motor system short circuit.	* Vac motor wiring fault / motor fault.	* Vac motor will not operate.	* Check vacuum motor and wiring	* Replace motor and any damaged wiring. * Cycle key switch to resume normal operation.	
* 8 Bars flash continuously. 	* Control system trip.	* Seat switch failure.	* Machine does not operate.	* Check seat switch wiring.	* Replace wiring as required.	
* 9 Bars flash once with pause. 	* Flashing beacon failure to operate.	* Beacon short circuit.	* Flashing beacon does not operate in accordance with safety requirements.	* Check wiring and connections to device.	* Replace damaged components. * Cycle Key switch to resume normal operation.	
* 9 Bars flash 3 times with pause.	* Water pump failure to operate.	* Failure of pump or wiring short circuit.	* No water supplied to cleaning heads.	* Check wiring and connections to pump.	* Replace damaged components. * Cycle Key switch to resume normal operation.	
* 9 Bars flash 4 times with pause.	* Detergent pump failure to operate.	* Failure of pump or wiring short circuit.	* No detergent supplied in water mix to cleaning head.	* Check wiring and connections to pump.	* Replace damaged components. * Cycle Key switch to resume normal operation.	
* 9 Bars flash 5 times with pause.	* Solenoid brake circuit failure.	* Failure of solenoid or wiring.	* Machine will not move.	* Check wiring and connections to brake.	* Replace damaged components. * Cycle Key switch to resume normal operation.	
* 10 bars flash continuously 	* Supply voltage to controller has exceeded 40 volts.	* Battery and motor connections may have become loose.	* Possible long term damage to controller if fault persists.	* Check battery wiring, trio drive and motor connections.	* Replace damaged components. * Cycle Key switch to resume normal operation.	
* Bars cycle up and down continuously (from 1 to 10 and 10 back to 1) and repeats.	* Accelerator pedal movement detected during Vario start up sequence (partially pressed or jammed).	* Foot or object on pedal during switch on or possible jamming of pedal.	* Machine will not operate.	* Remove object and ensure pedal is not jammed or depressed during switch on of Vario.	* Cycle Key switch to resume normal operation .	
* Bars cycle from 1 to 10 continuously and repeats.	* Machine inhibit.	* Controller/harness incorrectly wired.	* Machine will not operate.	* Check controller and harness wiring with special attention to wires p2/03 and p2/10.	* Correct wiring. * Cycle Key switch to resume normal operation	
* No indication on display.	* Horn and beacon failure.	* Replace 20 Amp fuse (if this doesn't fix fault replace horn or beacon)				
* No indication on display.	* Brush motors continuously either off or on while in transport mode.	* Microswitch failure.	* Brushes will not operate correctly.	* Check wiring and microswitch on underside of machine by brushes ensuring microswitch is clear of debris.	* Replace/clean damaged components.	
* No indication on display.	* VAC motor continuously either off or on.	* Microswitch failure.	* Vacuum will not operate correctly.	* Check wiring and microswitches behind floor tool handle.	* Replace/clean damaged components.	

## Trouble Shooting

PROBLEM	CAUSE	SOLUTION
Machine will not operate	Missing or blown fuses Key in position '0' (OFF) Low battery charge Machine isolator button in 'OFF' mode Machine is connected and charging Waste tank full switch stuck or clogged	Fit or replace fuse (page 8) Turn key to position '1' (ON) (page 8) Charge batteries (page 20) Reset isolator (page 17) Take off charge (page 20) Inspect and clean switch (page 16 / 18)
Vacuum will not operate	Floor-tool in raised position Waste-water tank full	Lower floor-tool (page 14) Empty waste-water tank (page 18)
Poor water pick-up	Waste-water tank full Clogged / blocked vacuum hose Loose hose connections Debris basket filter clogged / blocked Separator filter clogged / blocked Poor separator seal Damaged separator seal Damaged / split vacuum hose Damaged floor-tool blades Low battery charge	Empty waste-water tank (page 18) Remove and clean (page 18) Push tight connections (page 9) Remove and clean (page 18) Remove and clean (Page 18) Clean and refit (page 18) Renew (contact service dept) Renew (contact service dept) Renew (contact service dept) Recharge batteries (page 20)
No brush / scrub function	No brushes fitted Brush deck raised	Check and fit (page 11) Lower brush deck (page 14)
Little or no water flow	Clean-water tank empty Clean-water tank filter blocked/ clogged Incorrect water flow setting Brush deck raised	Fill clean-water tank (page 12) Remove and clean (18) Adjust as desired (Page 15) Lower brush deck (page 14)
Little or no dosing solution flow	Chemical dosing tank empty Incorrect dosing flow setting	Fill dosing-tank (page 13) Adjust as desired (page 15)
Machine just 'stops' while operating	Too much load on the brush system	Reset the machine using the key and decrease the brush load to best suit the floor type (page 16)
Machine will not operate in reverse	Floor-tool in lowered position 'Causes Battery Indicator to Flash'	Raise floor-tool (page 14)

***In the event of a breakdown contact your Numatic dealer or the  
Numatic Technical helpline +44 (0)1460 269268  
(See back page for company addresses or dealers stamp)***

## Specifications

Brush Motors	Vac Motor	Power	Noise Max decibel level at 1 meter	Run Time	Charging Time	Traction Drive	Transit Speed	Cleaning Speed	Climbing Gradient	Scrub Widths
3 x 24V 400 W	24V 600 W	6 x 12V = 300 Ahr	≤ 70 dB(A)	3.5 hrs	12 - 14 hrs	600 W	0-7.0 km/h	0-3.5 km/h	11%	650 mm 750 mm 850 mm
Brush Speed	Water Capacity	Nuchem Capacity	Water Flow rate	Nuchem Mix	Gross Weight (Full)	Gross Weight (Full) Plus 75KG Operator	Hand Arm Vibration Measurement	Whole Body Vibration Measurement	Dimensions	
50/100 150/200 rpm	120 L	5 L	4 L/min 3 L/min 2 L/min 1 L/min	25:1 50:1 75:1 100:1	620 Kg	695 Kg	2.1 m/s <sup>2</sup> (BS EN ISO 5349) Uncertainty 1%	0.525 m/s <sup>2</sup> (ISO 2631-1) Uncertainty 1%	H x 1425 mm L x 1676 mm W x 1054 mm	
RTU Weight	RTU Weight + 75Kg Operator		NET Weight	NET Weight Less Batteries		Battery Weight	Battery Dimensions			
620 Kg	695 Kg		500 Kg	315.2 Kg		30.8 Kg	H - 210mm L - 330mm W - 170mm			

## Spare Parts & Accessories

<b>BRUSHES:</b>		<b>GENERAL PARTS:</b>	
<b>606174</b>	330mm Octo Polyscrub Brush	<b>206953</b>	Detent Pin
<b>606172</b>	330mm Octo Nyloscrub Brush	<b>208167</b>	Spare Set of Keys (2 Keys)
<b>606176</b>	330mm Octo Longlife Brush	<b>208165</b>	Bulb
<b>606407</b>	330mm Padloc Octo Drive Board	<b>280001</b>	Seat Cover
<b>SQUEEGEE:</b>		<b>206947</b>	Splash Skirt
<b>900523</b>	Complete 850 Squeegee Assembly	<b>206939</b>	Rear Wheel
<b>900520</b>	Squeegee 850 Blade Set - Serilor PU FR & RR	<b>303827</b>	38mm Dosing Tank Cap
<b>208497</b>	Squeegee Castor	<b>304456</b>	42mm Dosing Tank Cap
<b>208796</b>	Squeegee Buffer Wheel	<b>220386</b>	Charging Lead V17 - UK
<b>FILTERS:</b>		<b>221079</b>	Charging Lead V34 - EURO
<b>208360</b>	Weighted Filter	<b>221047</b>	40 AMP Maxi Fuse
<b>208417</b>	Filter Basket	<b>DRIVE MOTOR SPARE PARTS:</b>	
<b>206439</b>	Basket Filter	<b>904964</b>	Drive Wheel Unit
<b>208790</b>	Bottom Tank Filter	<b>321506</b>	Brake
<b>206265</b>	Barrel Filter (Separator)	<b>208145</b>	Wheel
<b>HOSES:</b>		<b>208146</b>	Armature Brush
<b>213059</b>	Floor Tool Hose	<b>208147</b>	Motor Brush
<b>213060</b>	Vac Hose	<b>208148</b>	Friction Disc
<b>280018</b>	Top Tank Hose	<b>208149</b>	Rubber Gasket
<b>213025</b>	Bottom Tank Dump Hose	<b>208151</b>	Pinion
<b>304439</b>	Hose Closure (Bottom Tank)	<b>208152</b>	Steering Chain
<b>900903</b>	Hose Closure (Top Tank)	<b>208153</b>	Steering Chain Master Link
<b>237718</b>	Hose Guide		





**EU DECLARATION  
OF  
CONFORMITY**

We hereby declare under our sole responsibility that the following equipment fulfils all the relevant provisions of the following EU Directives

---

Machinery Directive 2006/42/EC  
EMC Directive 2014/30/EU  
RoHS Directive 2011/65/EU

---

Machine Description: Scrubber Dryer  
Machine Type: TTV, TRO, CRO, CRG, TRG Series.

---

Relevant standards upon which conformity is declared include:

EN 60335-1: 2012 + A11:2014  
EN 60335-2-72: 2012  
EN 55014-1: 2006 + A1:2009 + A2:2011  
EN 55014-2: 1997 +A1:2001 + A2:2008  
EN 61000-3-2: 2014  
EN 61000-3-3: 2013  
EN 62233: 2008

---

A technical construction file for this equipment is retained at the manufacturer's address under the authorisation of the following signatory:

Name: Allyn Boyes Position: Development Manager

Signed

Date

6/12/18



Numatic International Ltd  
Chard Somerset  
TA20 2GB  
www.numatic.co.uk

**GB**

**This Machine Has Been Packed  
With The Following**

Brush / Pad  
Floor Tool  
NuTab  
Charging Lead  
Fuse Pack

*Signed*

Distributed by:

  
1205 Britannia Road East  
Mississauga Ontario L4W 1C7  
Canada  
Telephone: (800) 387 3210  
Fax: (800) 709 2896  
<http://www.nacecare.com>

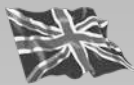

Numatic International Limited.  
Chard, Somerset TA20 2GB ENGLAND  
Tel.: 01460 68600 [www.numatic.co.uk](http://www.numatic.co.uk)



Numatic International GmbH. Fränkische Straße 15-19  
D-30455 Hannover, DEUTSCHLAND  
Tel.: 05 11 98 42 16 0 [www.numatic.de](http://www.numatic.de)



Numatic International SAS. 13 / 17 rue du Valengelier  
77500 CHELLES, FRANCE  
Tel: 01 64 72 61 61 [www.numatic.fr](http://www.numatic.fr)



BeNeLux Distribution, Numatic International BV  
Postbus 101, 2400 AC Alphen aan den Rijn, NEDERLAND  
Tel: 0172 467 999 [www.numatic.nl](http://www.numatic.nl)

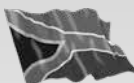

Numatic International (Pty.) Ltd.  
16th & Pharmaceutical Roads, Midrand, Gauteng, SOUTH AFRICA 1685  
Tel: 0861 686 284 [www.numatic.co.za](http://www.numatic.co.za)



Numatic International Schweiz AG.  
Sihlbruggstrasse 142, 6340 Baar. SCHWEIZ  
Tel: 0041 (0) 41 76 80 76 - 0 [www.numatic.ch](http://www.numatic.ch)



Numatic International ULDA. Centro de Negócios da Maia,  
Rua Albino José Domingues, 581, 4470 - 034 Maia PORTUGAL  
Tel: +351 220 047 700 [www.numatic.pt](http://www.numatic.pt)

This Product has been comprehensively inspected and checked during every stage of its manufacture.  
Including an in-depth electrical safety and functionality test.

Specification subject to change without prior notice  
[www.numatic.co.uk](http://www.numatic.co.uk) © Numatic International Limited

235470 10/19 (A21)